

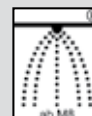

# fischer

## Hammerset anchor EA II

The mounting-friendly hammerset anchor for fast and secure fixing.

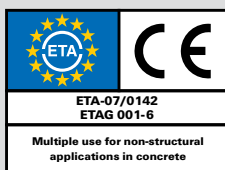
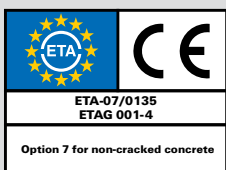
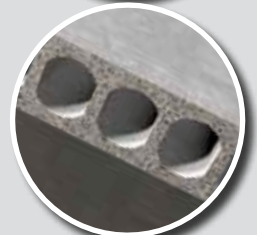

# Hammerset anchor EA II $h_{ef} = 25$ mm

## Internal threaded anchor with rim for easy impact installation.

The black fixing point prevents the anchor from falling out of the drill hole during overhead installation while it is in its unexpanded state.

The internal thread makes it possible to use standard threaded rods and screws in accordance with the approval.

The risk of reinforcement strikes is significantly reduced due to the short anchoring depth  $h_{ef} = 25$  mm. This enables fast and safe installation. The reduced drill hole depth enables even faster drilling progress.

Thanks to the low amount of setting power required, the EA II  $h_{ef} = 25$  mm can also be easily and quickly installed with a manual setting tool.

The rim prevents the anchor from slipping too far into the drill hole during installation.

Simple setting control: During installation, with setting tool EHS Plus, the edges are spread to give a clear visual indication that the anchor is correctly installed.

### Short and practical.

- The reduced drill hole depth of the EA II  $h_{ef} = 25$  mm enables even faster installation and reduces the risk of reinforcement strikes.
- ETA compliant utilisation of commercial threaded bars and screws is possible.
- The black fixings point prevents the anchor from falling out of the drill hole before being expanded.

#### Recommendation



- Approved for:
  - usage for (redundant) multiple fixing of non-load bearing systems in cracked concrete B25 to B55 and C20/25 to C50/60
- Also suitable for:
  - Concrete B15, natural stone with dense structure

#### Your advantages at a glance

- The installation properties of the EA II  $h_{ef} = 25$  mm makes drilling significantly easier and reduces hammer blows for expanding the hammerset anchor. This saves power and installation time.
- The black fixing point holds the anchor securely in the drill hole during overhead installation until the anchor has expanded completely.
- An imprint stamp integrated into the setting tool makes it possible to control the correct expansion of the anchor. This is done by the imprint, which is applied to the rim of the anchor during setting, and provides greater application security.

#### Installation EA II K



# Hammerset anchor EA II

## Internal threaded anchor with rim for easy impact installation.



The combined anchor sleeve and internal expanding cone unit provides ultimate load capacity in cracked and non-cracked concrete. The anchor sleeve is pressed from one piece without cutting making it exceptionally durable.

The internal thread enables the usage of threaded bars or screws with metric threading.



The integrally formed rim prevents the anchor from slipping deeper into the hole that has been drilled to deep and gives the installation point a more aesthetic look.

Simple setting control: During installation, with setting tool EHS Plus, the edges are spread to give a clear visual indication that the anchor is correctly installed.

### Easy and fast installation.

The hammerset anchor with a rim.



### The extensive product range.

The fischer hammerset anchor EA II is available in galvanized steel and stainless steel A4 (1.4401 and 1.4571). The approved product range includes threading sizes M6, M8, M10, M12, M16 and M20.

- The EA II M12x50 D model with thick sleeve is specifically designed for fixing diamond saws and core drill equipment.
- To prevent reinforcement strikes and for reduced drilling depth use EA II  $h_{ef} = 25$  mm.
- With its greater anchoring depth, the EA II M8 x 40 is especially designed for (single) fixings where a more cost-effective M8-threading diameter suffices but a higher load capacity is required.

#### Recommendation

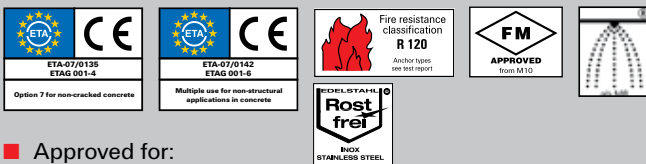

- Approved for:
  - non-cracked concrete B25 to B55 and C20/25 to C50/60
  - usage for (redundant) multiple fixing of non-load bearing systems in cracked concrete B25 to B55 and/or C20/25 to C50/60
- Also suitable for:
  - Concrete B15, natural stone with dense structure

#### Your advantages at a glance

- The rim prevents the anchor from slipping too deep into the drill hole.
- The EA II is easy to hammer in and expand.
- Maximum load capacity: The EA II uses the maximum load capacity of the (non-cracked) concrete. The EA II thereby has the greatest possible security reserves.
- Can be used with components thicker than 80 mm.
- The EA II M12x50 D with a greater sleeve diameter is specifically designed for fixing diamond saws and core drill equipment.

#### Installation EA II





# Applications.

## Plumbing / heating / electrical

### Pipelines



e. g. EA II M10 x 25

- Simple series installation of pipelines with suspended rails and threaded bars

### Ventilation ducts



e. g. EA II M10 x 30

- For fast multiple fixing of ventilation ducts as well as single suspension of spiral ducts

### Installation rails



e. g. EA II M8 x 25

- Approved fixing in pre-stressed hollow-core ceilings with a slab thickness of 35mm or more
- Fire protection certificate with an anchor length of 25mm

### Single pipe suspension



e. g. EA II M8 x 25

- Flexible and installation-friendly anchoring of single pipes with threaded bars

### Sprinklers



e. g. EA II M12 x 25

- Approved fixing of sprinkler lines in concrete

### Shuttering props



e. g. EA II M16 x 65

- For temporary anchoring of braces or shuttering props

### Diamond drill equipment fixing



e. g. EA II M12 x 50 D

- A special reinforced version for secure fixing of diamond drill equipment

# Multiple or single fixing?

## Application examples.

The EA II is used in general construction and civil engineering as well as for metalwork and constructional steelwork (**single**) fixing (ladders, shuttering props, structural steelwork) in non-cracked concrete, when failure of the fixing point would endanger life and limb or cause significant economic damage.

Furthermore, the EA II is particularly used in building technology for (**multiple**) fixing of redundant, non-load bearing systems such as, e.g. suspended ceilings, pipelines, cable lines in cracked and non-cracked concrete.

## What are multiple fixings?

With multiple fixings it is assumed that in the event of a large displacement or even the failure of an anchor, the load can be transferred to adjacent anchors. The component that is to be fixed is capable of absorbing the displacement that emerges hereby within the scope of usability. At the same time, the system can transfer the load to neighbouring fixing points.

Multiple fixing is defined by Annex 1 of the ETAG 001, Part 6.

The following applies for Germany:

- at least **4 fixing positions**, whereby a fixing point consists of at least one anchor and the design load  $N_{Sd}$  maximal **3 kN** or
- at least **3 fixing positions**, whereby a fixing point consists of at least one anchor and the design load  $N_{Sd}$  maximal **2 kN**.

## Difference between single and multiple

### Single fixing

Anchor failure

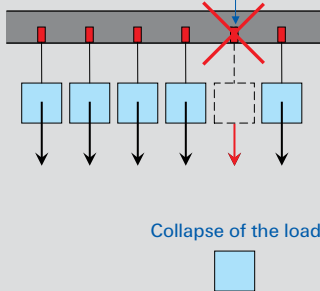

Collapse of the load

### Multiple fixing

Anchor failure or larger displacement

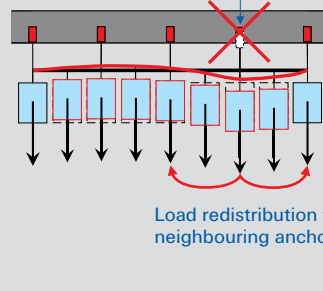

Load redistribution to neighbouring anchors

Original position

Position after load redistribution

The anchors do not have to be arranged in a row (as shown in the simplified examples), in other words, an anchor arrangement on the surface within the limits defined by the approval regulations is also possible.

With the European Technical Assessment for multiple fixings of non-load bearing systems, fixings are not only possible on the ceiling (e.g. light projecting roof) but on the wall as well.

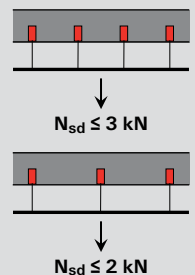

# Loads.

## Hammerset anchor EA II (screw strength class 4.6)

The highest admissible load for a single anchor<sup>1)</sup> for use in multiple fixing in normal concrete C20/25 to C50/60<sup>5)</sup>. The entire regulatory approval ETA-07/0142 should be observed for dimensioning.

cracked or non-cracked concrete						
Model	Effective anchoring depth $h_{ef}$ [mm]	Min. component thickness $h_{min}^{4)}$ [mm]	Maximum installation torque $T_{inst,max}$ [Nm]	Admissible load $F_{zul}^{3)}$ [kN]	Min. axial spacing $s_{min}^{2)}$ [mm]	Min. edge clearance $c_{min}^{2)}$ [mm]
EA II M6 x 25	25	120	4.0	1.0	30	60
EA II M6 x 30	30	120	4.0	1.2	65	115
EA II M8 x 25	25	120	8.0	1.4	50	100
EA II M8 x 30	30	120	8.0	2.0	70	115
EA II M8 x 40	40	120	8.0	2.0	70	115
EA II M10 x 25	25	120	15.0	1.9	60	100
EA II M10 x 30	30	120	15.0	2.0	85	140
EA II M10 x 40	40	120	15.0	3.0	95	150
EA II M12 x 25	25	120	35.0	1.9	100	110
EA II M12 x 50	50	120	35.0	4.3	145	200

## Hammerset anchor EA II (screw strength class 4.6)

The highest admissible load for a single anchor<sup>1)</sup> for use in multiple fixing in normal pre-stressed concrete hollow-core ceilings<sup>6)</sup>. The entire regulatory approval ETA-07/0142 should be observed for dimensioning.

Pre-stressed concrete hollow-core ceilings						
Model	Mirror thickness [mm]	Effective anchoring depth $h_{ef}$ [mm]	Maximum installation torque $T_{inst,max}$ [Nm]	Admissible load $F_{zul}^{3)}$ [kN]	Min. axial spacing $s_{min}^{2)}$ [mm]	Min. edge clearance $c_{min}^{2)}$ [mm]
EA II M6 x 25	≥ 35 <sup>7)</sup>	25	4.0	1.0	200	150
EA II M8 x 25			8.0	1.4		
EA II M10 x 25			15.0	1.9		
EA II M12 x 25			35.0	1.9		

## Hammerset anchor EA II A4 (screw strength class A4-50)

The highest admissible load for a single anchor<sup>1)</sup> for use in multiple fixing in normal concrete C20/25 to C50/60<sup>5)</sup>. The entire regulatory approval ETA-07/0142 should be observed for dimensioning.

cracked or non-cracked concrete						
Model	Effective anchoring depth $h_{ef}$ [mm]	Min. component thickness $h_{min}^{4)}$ [mm]	Maximum installation torque $T_{inst,max}$ [Nm]	Admissible load $F_{zul}^{3)}$ [kN]	Min. axial spacing $s_{min}^{2)}$ [mm]	Min. edge clearance $c_{min}^{2)}$ [mm]
EA II M6 x 30 A4	30	120	4.0	1.2	65	115
EA II M8 x 30 A4	30	120	8.0	2.0	70	115
EA II M8 x 40 A4	40	120	8.0	2.0	70	115
EA II M10 x 30 A4	30	120	15.0	2.0	85	140
EA II M10 x 40 A4	40	120	15.0	3.0	95	150
EA II M12 x 50 A4	50	120	35.0	4.3	145	200

### Hammerset anchor EA II (screw strength class 8.8)

The highest admissible load for a single anchor<sup>8)</sup> in normal concrete C20/25 non-cracked<sup>11)</sup>

The entire regulatory approval ETA-07/0135 should be observed for dimensioning.

non-cracked concrete							
Model	Effective Anchoring depth $h_{ef}$ [mm]	Min. component thickness $h_{min}$ [mm]	Max. installation torque $T_{inst,max}$ [Nm]	Admissible tensile load $N_{zul}^{10)}$ [kN]	Admissible shear load $V_{zul}^{10)}$ [kN]	Min. axial spacing $s_{min}^{9)}$ [mm]	Min. edge clearance $c_{min}^{9)}$ [mm]
EA II M6 x 30 <sup>12)</sup>	30	120	4.0	4.0	3.9	65	115
EA II M8 x 30 <sup>12)</sup>	30	120	8.0	4.0	4.9	70	115
EA II M8 x 40	40	120	8.0	6.1	4.9	70	115
EA II M10 x 30 <sup>12)</sup>	30	120	15.0	4.0	6.2	85	140
EA II M10 x 40	40	120	15.0	6.1	6.2	95	150
EA II M12 x 50	50	120	35.0	8.5	11.3	145	200
EA II M12 x 50 D	50	120	35.0	8.5	15.4	145	200
EA II M16 x 65	65	160	60.0	12.6	18.3	180	240
EA II M20 x 80	80	200	120.0	17.2	29.1	190	280

### Hammerset anchor EA II A4 (screw strength class A4-70)

The highest admissible load for a single anchor<sup>8)</sup> in normal concrete C20/25<sup>11)</sup>

The entire regulatory approval ETA-07/0135 should be observed for dimensioning.

non-cracked concrete							
Model	Effective anchoring depth $h_{ef}$ [mm]	Min. component thickness $h_{min}$ [mm]	Max. installation torque $T_{inst,max}$ [Nm]	Admissible tensile load $N_{zul}^{10)}$ [kN]	Admissible shear load $V_{zul}^{10)}$ [kN]	Min. axial spacing $s_{min}^{9)}$ [mm]	Min. edge clearance $c_{min}^{9)}$ [mm]
EA II M6 x 30 A4 <sup>12)</sup>	30	120	4.0	4.0	3.2	65	115
EA II M8 x 30 A4 <sup>12)</sup>	30	120	8.0	4.0	5.6	70	115
EA II M8 x 40 A4	40	120	8.0	6.1	5.6	70	115
EA II M10 x 30 A4 <sup>12)</sup>	30	120	15.0	4.0	6.9	85	140
EA II M10 x 40 A4	40	120	15.0	6.1	7.1	95	150
EA II M12 x 50 A4	50	120	35.0	8.5	12.9	145	200
EA II M12 x 50 D A4	50	120	35.0	8.5	13.5	145	200
EA II M16 x 65 A4	65	160	60.0	12.6	21.1	180	240
EA II M20 x 80 A4	80	200	120.0	17.2	33.7	190	280

1) The Partial Safety Factors regarding resistance as well as a Partial Safety Factor regarding the effect of  $\gamma_F = 1.4$  are taken into account.

2) Smallest possible axial spacing and edge clearance with simultaneous increase of structural component thickness. The combination of minimal axial clearance and edge clearance with minimal structural component thickness is not possible. See Certificate of Approval for exact data.

3) Applies to tension load, shear load and diagonal pull under each angle. See Certificate of Approval for combinations of tension and shear loads as well as for bending moments.

4) Smallest possible structural component thickness with simultaneous increase of axial spacing and edge clearance. The combination of minimal axial clearance and edge clearance with minimal structural component thickness is not possible. See Certificate of Approval for exact data.

5) Admissible loads for concrete strength class C12/15 see Certificate of Approval.

6) Concrete strength class C30/37 to C50/60.

7) The anchors can be used for loads with the same characteristic load with a mirror thickness of  $d_b = 30$  mm as long as the drill hole has not cut a hollow cavity.

8) The Partial Safety Factors regarding resistance as well as the Partial Safety Factor regarding the effect of  $\gamma_F = 1.4$  have been taken into account. A single anchor is classified e.g. as an anchor with an axial spacing of  $s \geq 3 \times h_{ef}$  and an edge clearance of  $c \geq 1.5 \times h_{ef}$ . See Certificate of Approval for exact data.

9) Smallest possible axial spacing and edge clearance with simultaneous reduction of the admissible load.

10) See Certificate of Approval for combinations of tension and shear loads, bending moments as well as reduced axial spacing and edge clearance (anchor groups).

11) Greater admissible loads are possible with higher concrete strengths up to C50/60.

12) Limited to statically indeterminate structural components.

# Product range.



Hammerset anchor **EA II**,  
with reduced anchoring depth  
 $h_{ef}$  25 mm.



Hammerset anchor **EA II**,  
**not suitable for fixing diamond  
drill equipment and diamond saws.**

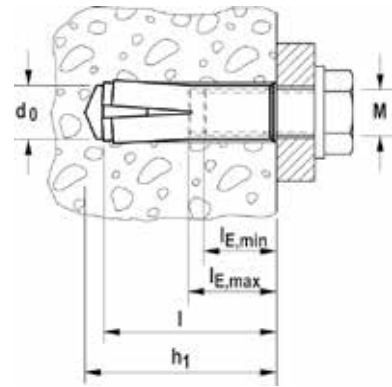

## EA II

Item description	Steel, galvanised	Stainless steel	Approval ETA	Nominal drill bit diameter	Min. drill hole depth for push-through installations	Anchor length l [mm]	Inner threading A1	Min. screw-in depth $l_{E,min}$ [mm]	Max. screw-in depth $l_{E,max}$ [mm]	Sales unit [pcs]
	Item no. gvz	Item no. A4		$d_0$ [mm]	$h_1$ [mm]					
EA II M 6 x 25	532230	—	■	8	27	25	M 6	6	14	100
EA II M 6 x 30	048264	048410	■	8	32	30	M 6	6	14	100
EA II M 8 x 25	532231	—	■	10	27	25	M 8	8	14	100
EA II M 8 x 30	048284	048411	■	10	33	30	M 8	8	14	100
EA II M 8 x 40	048323	048412	■	10	43	40	M 8	8	14	50
EA II M 10 x 25	532232	—	■	12	27	25	M 10	10	14	50
EA II M 10 x 30	048332	—	■	12	33	30	M 10	10	14	50
EA II M 10 x 40	048339	048414	■	12	43	40	M 10	10	17	50
EA II M 12 x 25	532233	—	■	15	27	25	M 12	12	14	25
EA II M 12 x 50	048406	048415	■	15	54	50	M 12	12	22	25
EA II M 16 x 65	048408	048416	■	20	70	65	M 16	16	28	20
EA II M 20 x 80	048409	048417	■	25	85	80	M 20	20	34	10

Related setting tool for installation by hand (EHS Plus), for installation with hammer drill (EMS).



Hammerset anchor  
**EA II M12 x 50 D.**  
Specifically designed for  
fixing diamond saws  
and core drill equipment.



Hammerset anchor  
**EA II M12 x 50 N D.**  
Specifically designed  
for fixing diamond  
drill equipment.

## EA II M

Item description	Steel, galvanised	Approval ETA	Nominal drill bit diameter $d_0$ [mm]	Min. drill hole depth $h_1$ [mm]	Anchor length l [mm]	Inner threading A1	Min. screw-in depth $l_{E,min}$ [mm]	Max. screw-in depth $l_{E,max}$ [mm]	Sales unit [pcs]
	Item no. gvz								
EA II M12 x 50 D	048407	■	16	54	50	M 12	12	22	25
EA M12 x 50 N D	500872	—	16	50	50	M 12	12	22	50

Related setting tool for installation by hand (EHS Plus), for installation with hammer drill (EMS).



# Product range.



Machine setting tool **EMS**  
(without imprint stamp)

## EMS

Item description	Item no.	Tool acceptance	Compatible with	Sales unit [pcs]
<b>EMS M6 x 25/30</b>	<b>048065</b>	SDS plus	EA II M 6 x 25, EA II M 6 x 30	1
<b>EMS M8 x 25/30</b>	<b>048066</b>	SDS plus	EA II M 8 x 25, EA II M 8 x 30	1
<b>EMS M8 x 40</b>	<b>048067</b>	SDS plus	EA II M 8 x 40	1
<b>EMS M10 x 25/30</b>	<b>048068</b> <sup>1)</sup>	SDS plus	EA II M 10 x 25, EA II M 10 x 30	1
<b>EMS M10 x 40</b>	<b>048070</b>	SDS plus	EA II M 10 x 40	1
<b>EMS M12 x 25</b>	<b>532569</b>	SDS plus	EA II M 12 x 25	1
<b>EMS M12 x 50</b>	<b>048071</b>	SDS plus	EA II M 12 x 50 D / EA II M 12 x 50 / EA M 12 x 50 N D	1
<b>EMS M 6 x 65</b>	<b>048072</b> <sup>1)</sup>	SDS max	EA II M 16 x 65	1
<b>EMS M20 x 80</b>	<b>048073</b> <sup>1)</sup>	SDS max	EA II M 20 x 80	1

<sup>1)</sup> Delivery period on request.



Setting tool **EHS Plus**  
with hand shock-protection  
for your safety (with imprint  
stamp)



Setting tool **EA-ST**  
(without hand shock-protection,  
without imprint stamp)

## EHS and EA-ST

Item description	Item no.	Compatible with	Sales unit [pcs]
<b>EHS M6 x 25/30 Plus</b>	<b>044630</b>	EA II M 6 x 25, EA II M 6 x 30	1
<b>EHS M8 x 25/30 Plus</b>	<b>044631</b>	EA II M 8 x 25, EA II M 8 x 30	1
<b>EHS M8 x 40 Plus</b>	<b>044632</b>	EA II M 8 x 40	1
<b>EHS M10 x 25/30 Plus</b>	<b>048487</b>	EA II M 10 x 25, EA II M 10 x 30	1
<b>EHS M10 x 40 Plus</b>	<b>044633</b>	EA II M 10 x 40	1
<b>EHS M12 x 25 Plus</b>	<b>532568</b>	EA II M 12 x 25	1
<b>EHS M12 x 50 Plus</b>	<b>044634</b>	EA II M 12 x 50, EA II M 12 x 50 D	1
<b>EHS M16 x 65 Plus</b>	<b>044635</b>	EA II M 16 x 65	1
<b>EHS M20 x 80 Plus</b>	<b>044636</b>	EA II M 20 x 80	1
<b>EA-ST 12</b>	<b>504585</b>	EA M 12 x 50 N D	1

# Advantages for professionals.

On the one hand, fire protection measures serve to protect property and on the other, their prime purpose is to protect human life.

- **Sprinkler systems** provide an effective fire warning and extinguishing function. fischer supplies the ideal fastening solution for safe sprinkler installation.
- In addition, the SaMontec products certified for fire protection facilitate fireproof installation of individual lines and pipeline routes. More information about **fireproof pipe fastening** can be found in the corresponding brochure.



The **international fixing catalogue** provides many facts and helps to make fast and safe product selections, for instance with:

- Product descriptions with overview of advantages / benefits
- Installation tips
- Application aids
- Detailed technical data
- The fundamentals of fastening technology

In short: Everything you need to know about professional fastening.



# fischer FIXPERIENCE.

## The new design and information software suite.



- The new modular design program includes engineering software and application modules.
- The software is based on international design standards (ETAG 001 and EC2), including the national application documents. All common force and measurement units are available.
- Incorrect input will be recognized and the software gives tips to get a correct result. This ensures a safe and reliable design every time.
- The graphical display can easily be rotated through 360°, panned, tilted or zoomed as required.
- The 3 D display gives a detailed and realistic image.
- The "live update" feature helps to keep the program up to date ensuring you are always working with the latest version.
- Free download and updates at [www.fischer.de/fixperience-en](http://www.fischer.de/fixperience-en)

## Our service to you.



We are available to you at any time as a reliable partner to offer technical support and advice:

- Our products range from chemical resin systems to steel anchors through to nylon anchors.
- Competence and innovation through own research, development and production.
- Global presence and active sales service in over 100 countries.
- Qualified technical consulting for economical and compliant fastening solutions. Also on-site at the construction site if requested.
- Training sessions, some with accreditation, at your premises or at the fischer ACADEMY.
- Free Design and construction software for demanding applications.

## This is what fischer stands for.



FIXING SYSTEMS



AUTOMOTIVE SYSTEMS



FISCHERTECHNIK



CONSULTING

Find information on the entire selection of fischer products in the extensive main catalogue or online at [www.fischer.de](http://www.fischer.de)

fischerwerke GmbH & Co. KG  
Klaus-Fischer-Strasse 1 · 72178 Waldachtal  
Germany  
Tel. +49 7443 12-0 · Fax +49 7443 12-4220  
[www.fischer.de](http://www.fischer.de) · [info@fischer.de](mailto:info@fischer.de)

fischer Austria GmbH  
Wiener Strasse 95 · 2514 Traiskirchen  
Austria  
Tel. +43 2252 53730-0 · Fax +43 2252 53730-70  
[www.fischer.at](http://www.fischer.at) · [technik@fischer.at](mailto:technik@fischer.at)

**fischer**   
*innovative solutions*